

**1**

APPLY EXPRESS MASK AND PAINT BEFORE GLUING  
 POUŽIT EXPRESS MASK NABARVIT PŘED SLEPENÍM

SYMMETRICAL ASSEMBLY  
 SYMETRICKÁ MONTÁŽ

REMOVE  
 ODSTRANIT

GRIND  
 OBROUSIT

DRILL HOLE  
 VRTAT OTVOR

**4** 3D DECAL PARTS  
 3D OBTISKY

**1** COLORED ETCHED PARTS  
 LEPTANÉ BAREVNÉ DÍLY

**1** ETCHED PARTS  
 LEPTANÉ NEBAREVNÉ DÍLY

**1** ORIGINAL KIT PARTS  
 PŮVODNÍ DÍLY STAVEBNICE

BEND  
 OHNOUT

OPTION  
 VOLBA

REPLACE  
 NAHRADIT

ORIGINAL KIT PARTS  
 PŮVODNÍ DÍLY STAVEBNICE

COLORED 3D DECAL PARTS  
 BAREVNÉ 3D OBTISKY

PHOTO-ETCHED PARTS  
 LEPTANÉ DÍLY

PARTS TO BE REMOVED  
 DÍLY K ODSTRANĚNÍ

FILL  
 TMELIT

**3DL 32007****Bf 108****1/32**

detail set for 1/32 EDUARD kit • sada detailů pro stavebnici 1/32 EDUARD

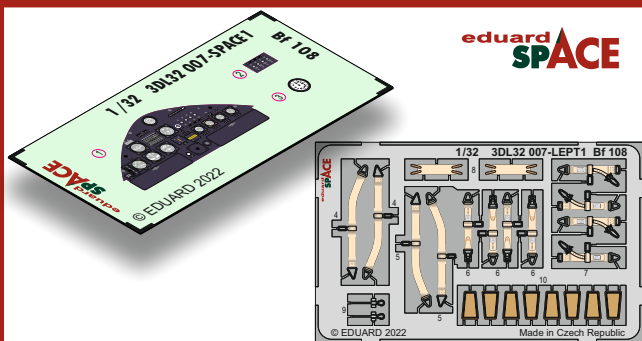
**2****3D decals**

•Soak the decal in the warm water for couple of seconds and after its separation from the backing paper position it on the model.

•To increase decal's adherence use the white glue, Mr. Mark Setter or apply to the glossy surface.

•Leaving decal in the water for too long can cause its swelling and distortion.

**PE parts**

•Use cyanoacrylate glue to attach.

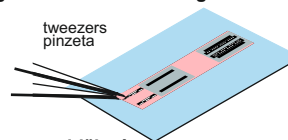
**3D decals**

•Vložte na několik vteřin do teplé vody a po oddělení od podkladového papíru naneste na model.

•Pro zvýšení přilnavosti lze použít disperzní lepidlo, Mr. Mark Setter či obtisk nanášet na lesklý povrch.

•Příliš dlouhé vystavení 3D obtisku vodě může způsobit jeho nabobtnání.

**PE parts**

•K lepení použijte kyanoakrylátové lepidlo.

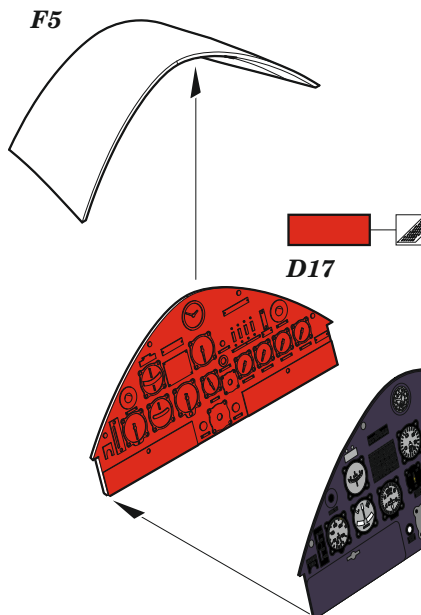
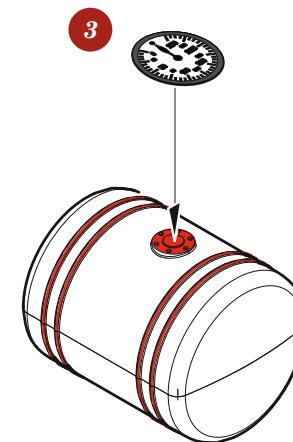
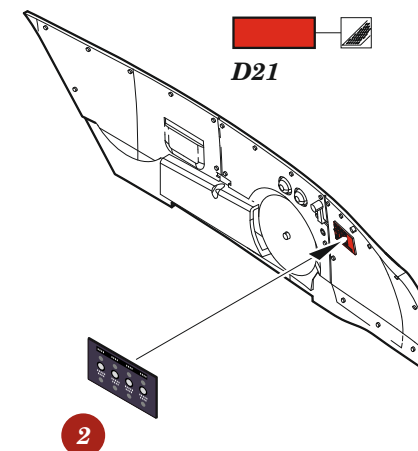
**3****A6, A11**

**A**

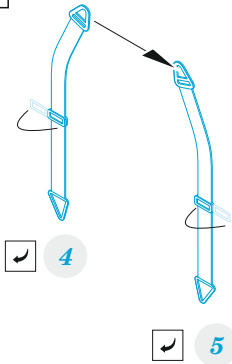

**B**

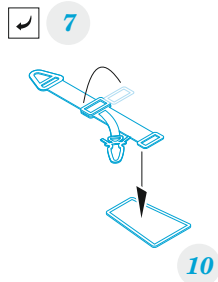

**C**

