

1

★ APPLY EXPRESS MASK AND PAINT BEFORE GLUING
POUŽIT EXPRESS MASK NABARVIT PŘED SLEPENÍM

☯ SYMMETRICAL ASSEMBLY
SYMETRICKÁ MONTÁŽ

✂ REMOVE
ODSTRANIT

☑ GRIND
OBROUSIT

⚪ DRILL HOLE
VRTAT OTVOR

4 3D DECAL PARTS
3D OBTISKY

1 COLORED ETCHED PARTS
LEPTANÉ BAREVNÉ DÍLY

1 ETCHED PARTS
LEPTANÉ NEBAREVNÉ DÍLY

1 ORIGINAL KIT PARTS
PŮVODNÍ DÍLY STAVEBNICE

↪ BEND
OHNOUT

❓ OPTION
VOLBA

Ⓜ REPLACE
NAHRADIT

↺ REVERSE SIDE
OTOČIT

■ ORIGINAL KIT PARTS
PŮVODNÍ DÍLY STAVEBNICE

■ COLORED 3D DECAL PARTS
BAREVNÉ 3D OBTISKY

■ PHOTO-ETCHED PARTS
LEPTANÉ DÍLY

■ PARTS TO BE REMOVED
DÍLY K ODSTRANĚNÍ

■ FILL
TMELIT

3DL 48168

U-2R

1/48

detail set for 1/48 HOBBY BOSS kit • sada detailů pro stavebnici 1/48 HOBBY BOSS

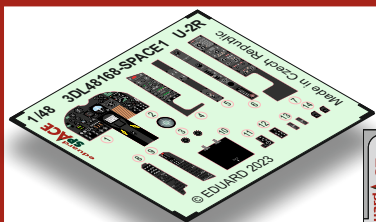

eduard
SPACE

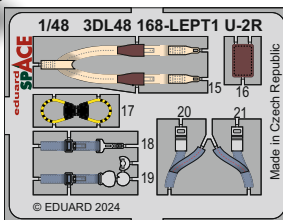

2

3D decals

• Soak the decal in the warm water for couple of seconds and after its separation from the backing paper position it on the model.

• To increase decal's adherence use the white glue, Mr. Mark Setter or apply to the glossy surface.

• Leaving decal in the water for too long can cause its swelling and distortion.

PE parts

• Use cyanoacrylate glue to attach.

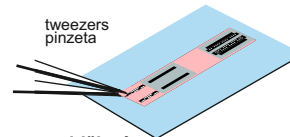

3D decals

• Vložte na několik vteřin do teplé vody a po oddělení od podkladového papíru naneste na model.

• Pro zvýšení přilnavosti lze použít disperzní lepidlo, Mr. Mark Setter či obtisk nanášet na lesklý povrch.

• Příliš dlouhé vystavení 3D obtisku vodě může způsobit jeho nabobtnání.

PE parts

• K lepení použijte kyanoakrylátové lepidlo.

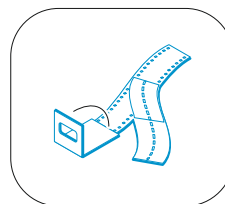

E6, E13, E15



21

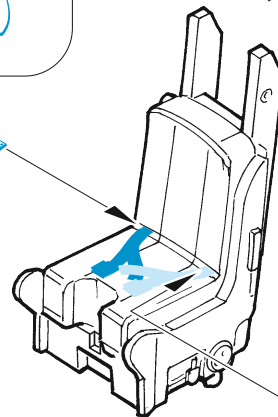

20

3

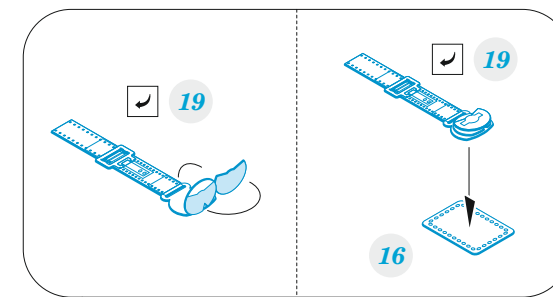

16

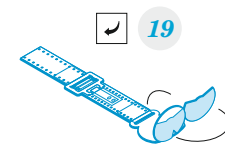

19

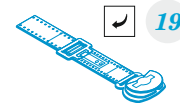

19

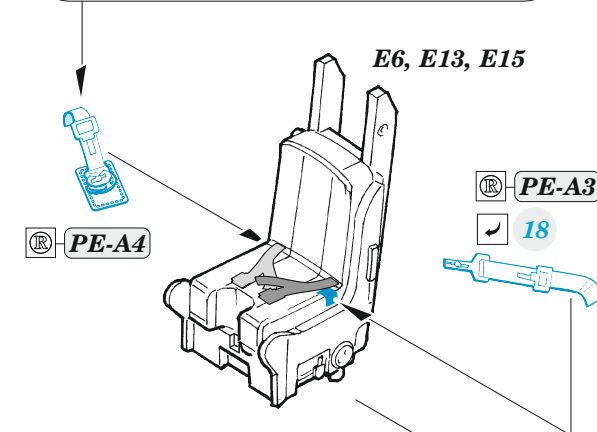

E6, E13, E15

PE-A4

PE-A3

18

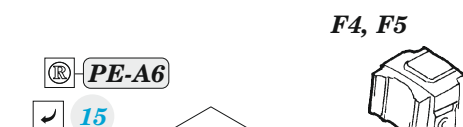

F4, F5

PE-A6

15

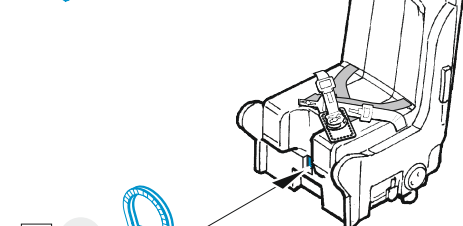
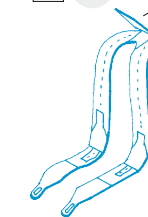

E6, E13, E15

17

F25

