

632 145 B-24 wheels (8 spoke front wheel)

for Hobby Boss kit - pro stavebnici Hobby Boss

eduard
BRASSIN

1/32 scale

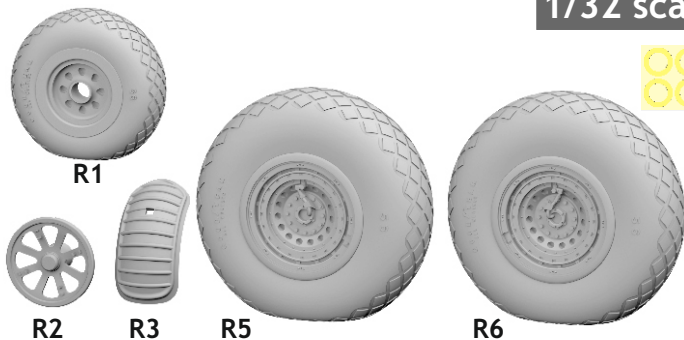

COLOURS

| GSI Creos (GUNZE) | | Mr.METAL COLOR | |
|-------------------|----------|----------------|--|
| AQUEOUS | Mr.COLOR | | |
| [H 8] | [C 8] | SILVER | |
| [H77] | [C137] | TIRE BLACK | |
| | | | |
| | | | |

This product contains metal and resin detail parts for upgrading scale plastic models. When selecting this set make sure that it is for the kit mentioned in product name as these sets are made specifically for that kit. When upgrading the model some cutting or corrections may be necessary for parts to fit accurately. **WARNING!** This set contains small and sharp parts. Work carefully in a ventilated and well-lit room. Safety glasses are recommended. This product is not suitable for children below 14 years of age.

Tento výrobek obsahuje leptané a odlévané detaily pro úpravu a vylepšení plastického modelu. Při výběru sady kovových detailů zkontrolujte, zda je určena pro model, který chcete upravit. Model, pro který je sada určena, je uveden u názvu výrobku. Pro přesnou aplikaci kovových a odlévaných dílů může být zapotřebí upravit díly upraveného modelu. **POZOR!** Sada obsahuje malé ostré díly. Pracujte ve větrané a dobře osvětlené místnosti. Doporučujeme použití ochranných brýlí. Tento výrobek není vhodný pro děti mladší 14 let.

eduard

www.eduard.com

16,95

435 21 Obrnice 170

Czech Republic



632 145 B-24 wheels (8 spoke front wheel)

for Hobby Boss kit - pro stavebnici Hobby Boss

1/32

BRASSIN







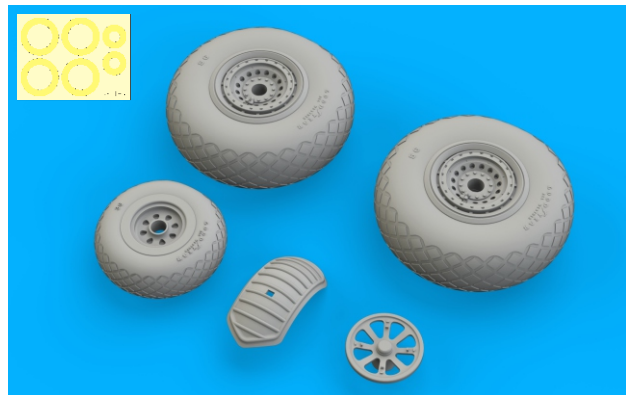



BRASSIN

eduard



BEST BRASS RESIN AROUND!

-  REMOVE
ODSTRANIT
-  GRIND
OBROUSIT
-  DRILL HOLE
VRTÁT OTVOR
-  SYMMETRICAL ASSEMBLY
SYMETRICKÁ MONTÁŽ
-  SCRIBE THE PANEL AND HOLES
RYTÍ
-  REVERSE SIDE
OTOČIT
-  BEND
OHNOUT
-  OPTION
VOLBA
-  REPLACE
NAHRADIT

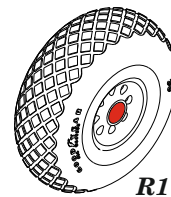
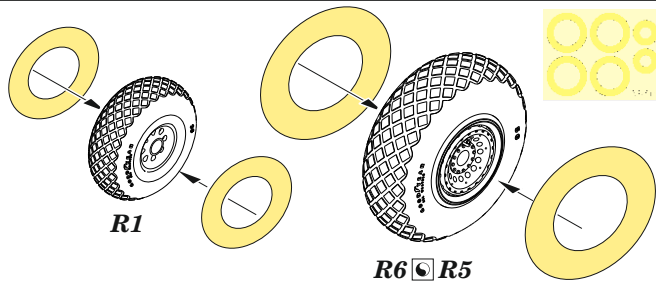

1

R6 - RIGHT SIDE
R5 - LEFT SIDE

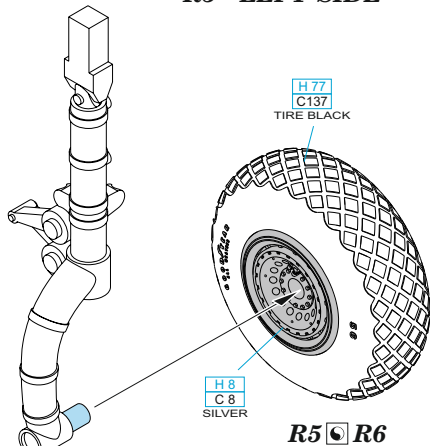

plastic parts

2

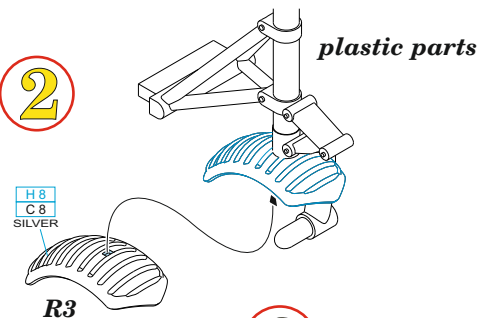

R3

3

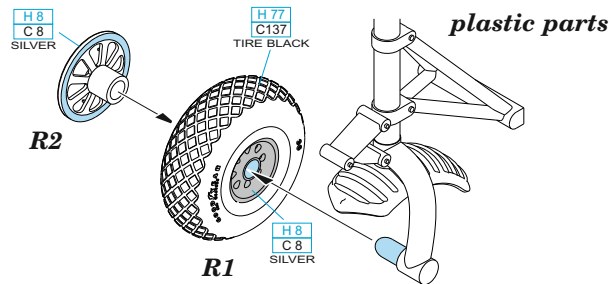

plastic parts