

**eduard**  
**MASK**

**JX 159**

# B-25J gun nose 1/32

The die-cut mask for accurate canopy frame painting of the  
*HK Models* scale 1/32 KIT

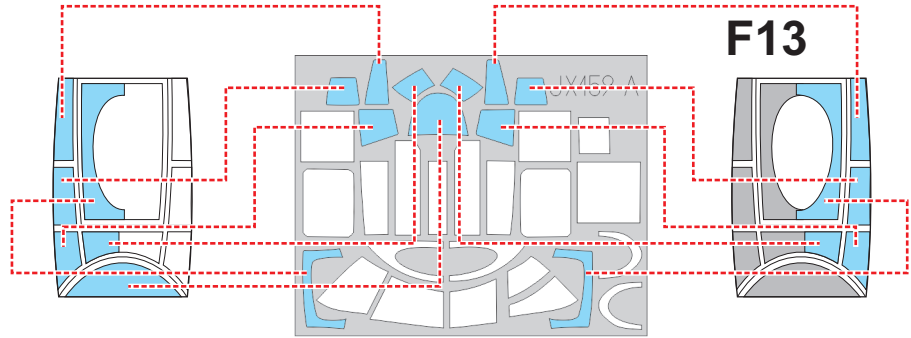
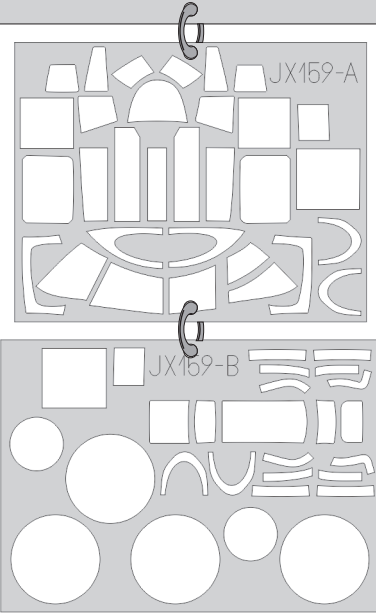

**F13**

**F13**

1.)

LIQUID MASK

**F13**

**F11**

2.)

**G2**  
LIQUID MASK

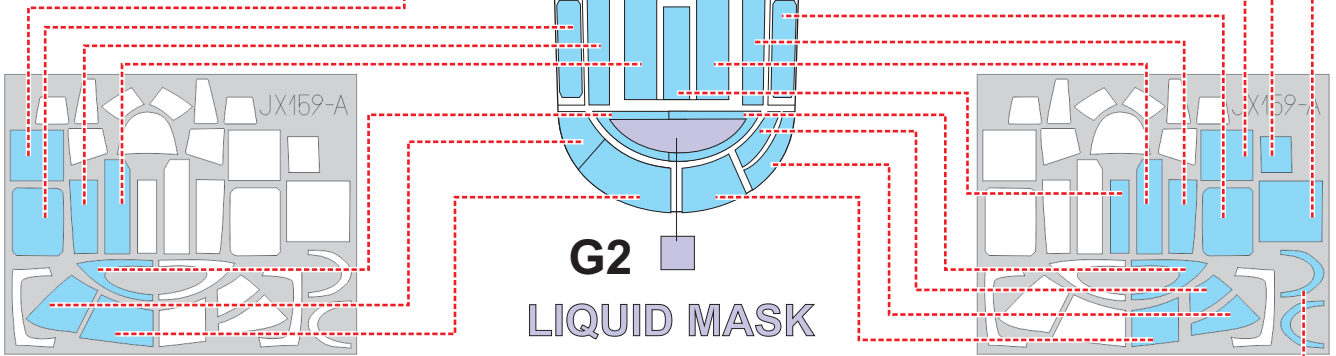

**N2**

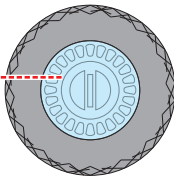

3.)

**F4**

**F5**

LIQUID MASK

**N2**

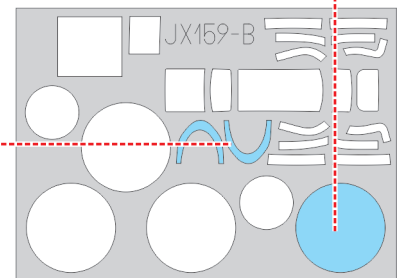
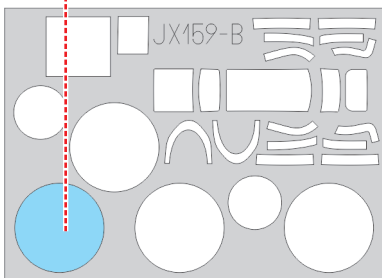
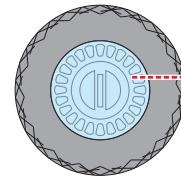

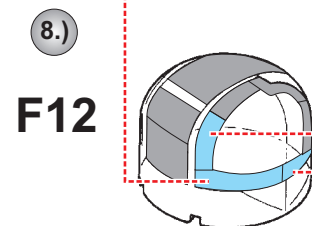
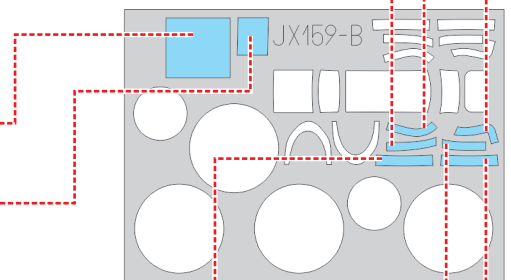
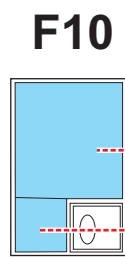
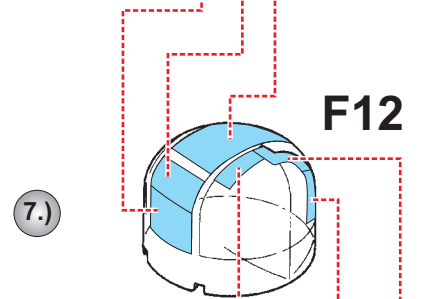
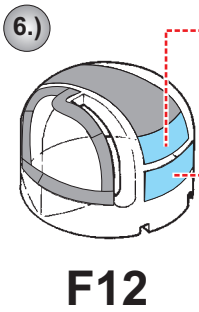
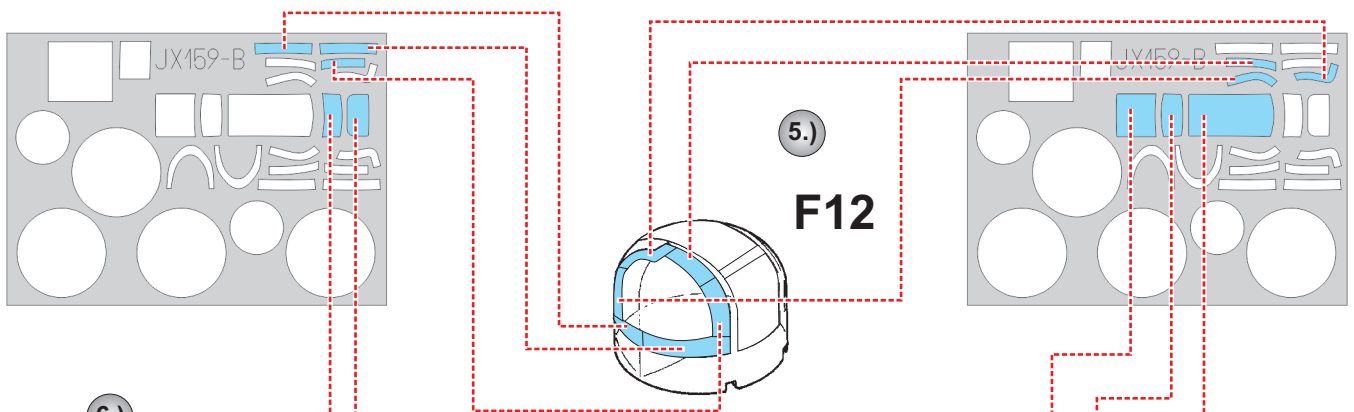
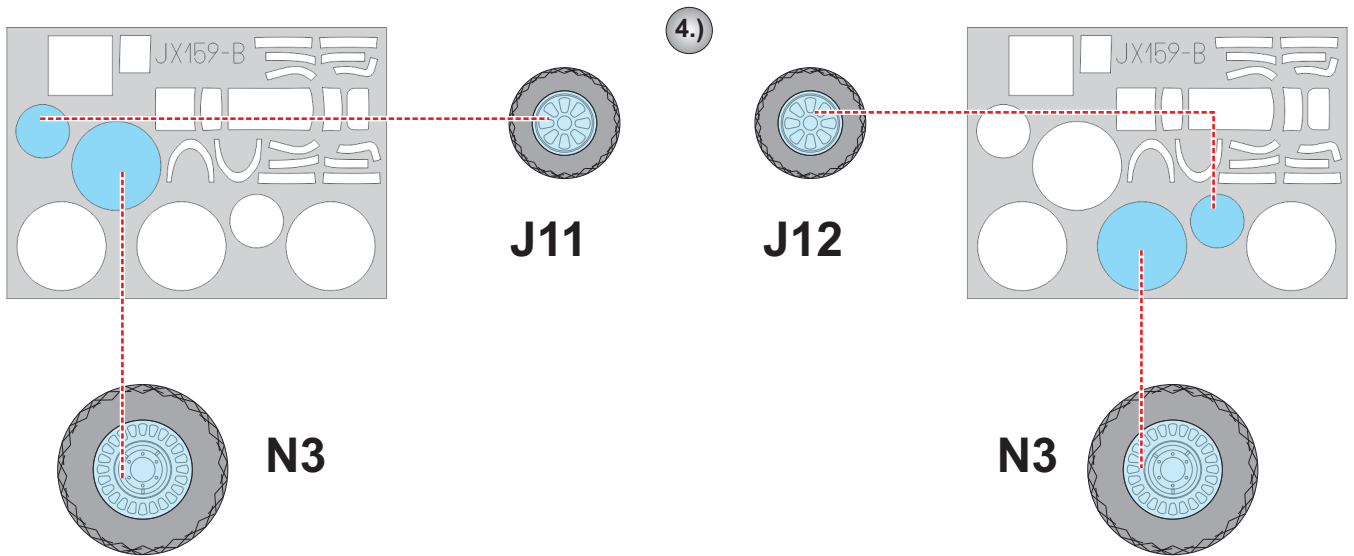

LIQUID MASK 9.)

