

märklin
H0

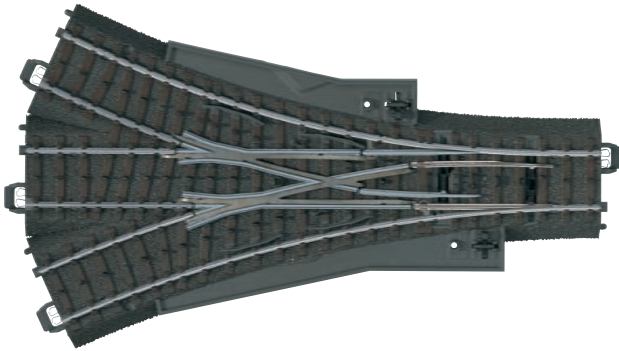

Dreiweg-Weiche
24630

Hand-Schalthebel serienmäßig
Comes from the factory with manual hand levers
Equipé de série d'un levier de commande manuel
Handhendel is standaard

Palancas manuales de serie
Leva per commutazione manuale montata di serie
Seriemässiga handspakar
Hånd-omskifter

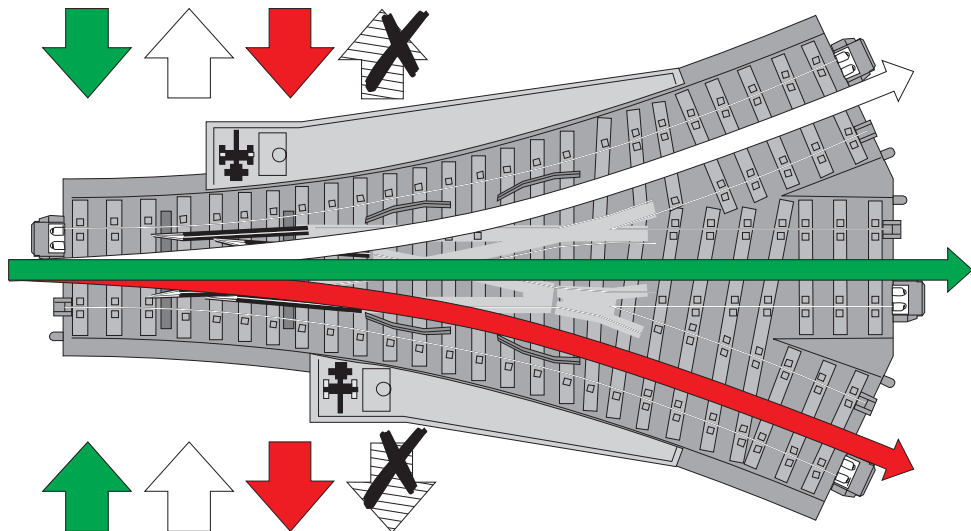

Abdeckung der Mechanik nicht abnehmen!
Do not remove the cover for the turnout linkage!
Ne pas enlever le cache de la partie mécanique!
Afdækning van het mechaniek a.u.b. niet afnemen!

¡No retirar la tapadera de la mecánica!
Si prega di non smontare il coperchio del
meccanismo!
Tag inte av höljet över mekaniken
Tag ikke mekanikkens afdækning af!

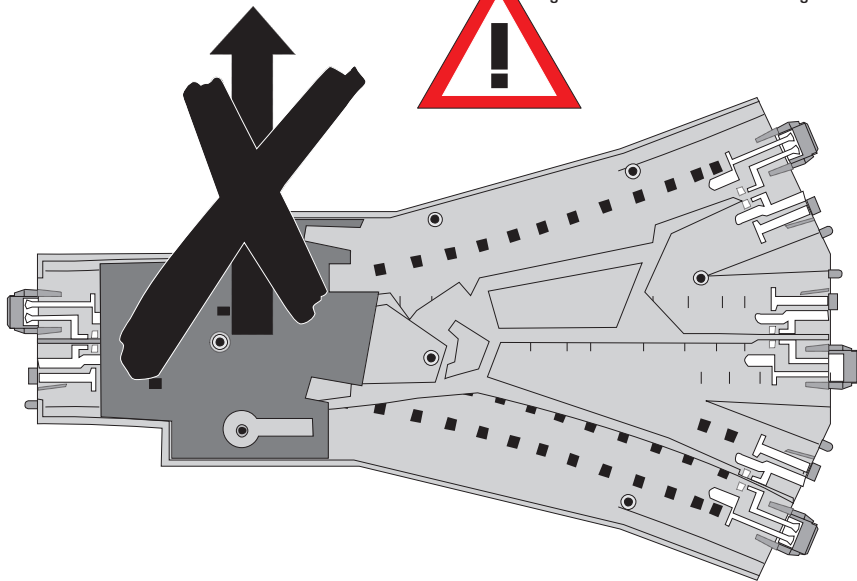

2 Elektro-Antriebe nachrüstbar
Can be retrofitted with 2 electric mechanisms
En option, 2 moteurs électromagnétiques
Tot electriscche wissel om te bouwen m.b.v.
2 wisselaandrijvingen

2 motores eléctricos para un montaje posterior
2 azionamenti elettromagnetici equipaggiabili in seguito
Kan efteråt försees med 2 elmagnetiska växelställare
Kan udstyres med to elektro-drev

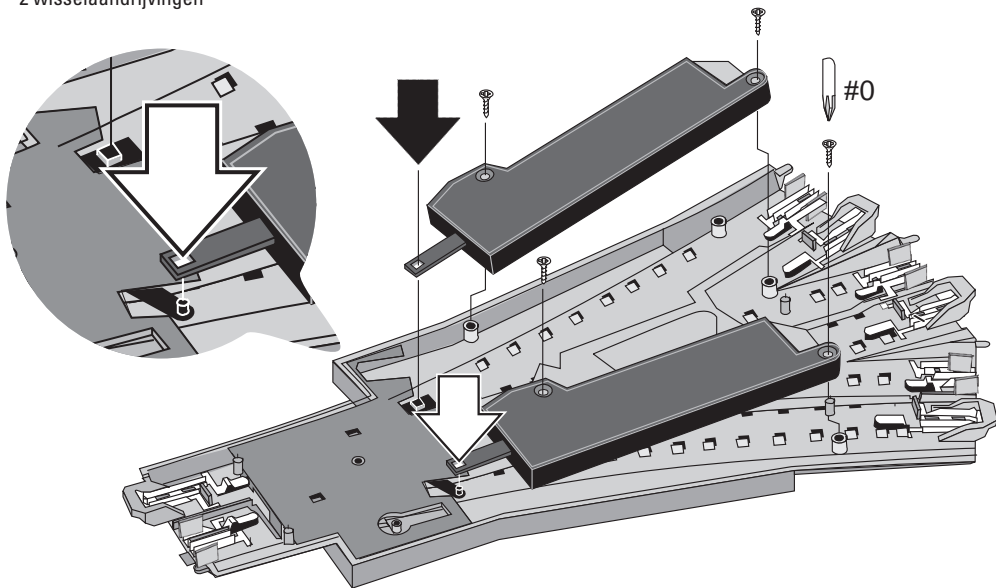

Konventioneller Betrieb:
Anschluss mit Stellpult
LED-Anzeige nur bei 72710

Conventional operation:
Connection to a control box
LED indicator only with 72710

Exploitation conventionnelle:
connexion au pupitre de commande
Affichage DEL uniquement sur le modèle 72710

Traditioneel bedrijf:
aansluiting met seinschakelaar
LED-indicatie alleen bij 72710

Funcionamiento convencional:
conexión con cuadro de mando
Señalización LED solamente con 72710

Funzionamento tradizionale:
collegamento con il quadro di comando
Indicazione con LED solo nel caso del 72710

Konventionell drift:
anslutning med ställpult
LED-indikering endast på 72710

Konventionel drift:
Tilslutning med kontrolpult
LED-display kun ved 72710

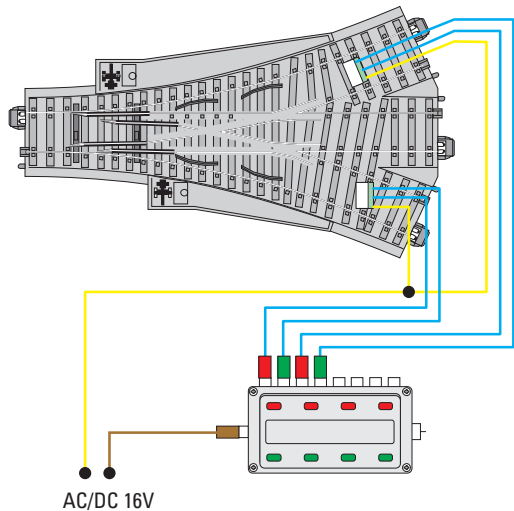

Digital-Betrieb:
Anschluss mit Decoder m83

Digital operation:
Connections with the m83 decoder

Fonctionnement Digital:
via un Décodeur m83

Bij digitaal-bedrijf:
aansluiten op decoder m83

Funcionamiento Digital:
conexiones con Decoder m83

Funzionamento Digital:
collegamento con Decoder m83

Digitaldrift:
Anslutning med decoder m83

Digitaldrift:
Tilslutning med Decoder m83

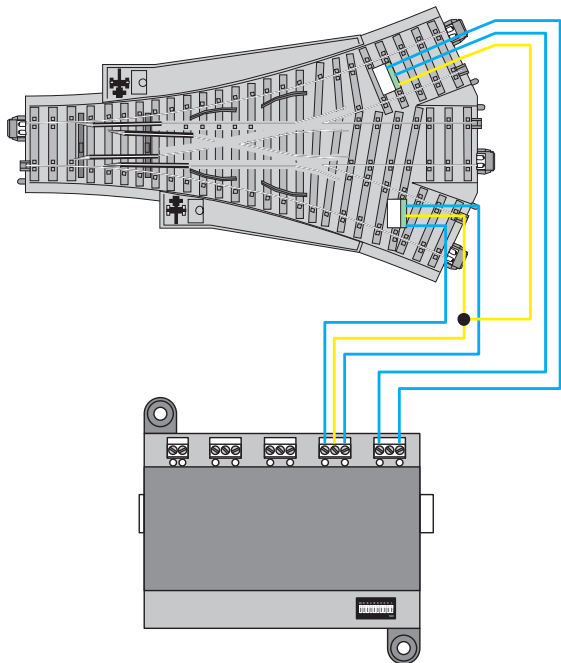

Dreiweg-Weiche am Stellpult
Three-way turnout at the control panel
Raccordement d'un aiguillage triple au pupitre de commande
Driewegwissel op schakelbord

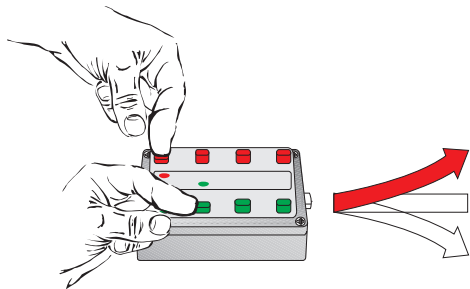

Desvío triple conectado al pupitre de mando
Deviatio a tre vie sul quadro di comando
Tredelad växel vid ställpult
Trevejs-sporskifte på styrepult

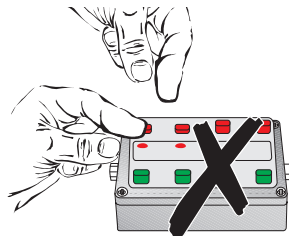
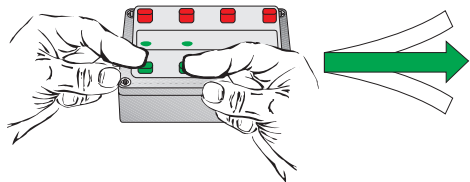
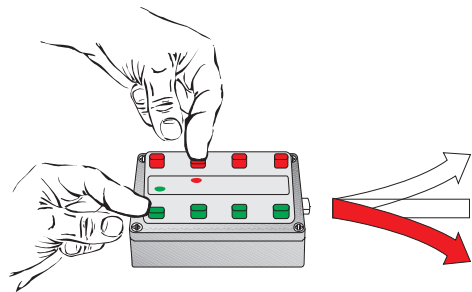

Gebr. Märklin & Cie. GmbH
Stuttgarter Straße 55 - 57
73033 Göppingen
Germany
www.maerklin.com



www.maerklin.com/en/imprint.html

601959/0819/Sc6Ef
Änderungen vorbehalten
© Gebr. Märklin & Cie. GmbH